

# NTD20N06L

## Power MOSFET 20 Amps, 60 Volts

### Logic Level, N-Channel DPAK

Designed for low voltage, high speed switching applications in power supplies, converters and power motor controls and bridge circuits.

#### Features

- Pb-Free Packages are Available

#### Typical Applications

- Power Supplies
- Converters
- Power Motor Controls
- Bridge Circuits

#### MAXIMUM RATINGS (T<sub>J</sub> = 25°C unless otherwise noted)

Rating	Symbol	Value	Unit
Drain-to-Source Voltage	V <sub>DSS</sub>	60	Vdc
Drain-to-Gate Voltage (R <sub>GS</sub> = 10 MΩ)	V <sub>DGR</sub>	60	Vdc
Gate-to-Source Voltage	V <sub>GS</sub>	± 15	Vdc
– Continuous	V <sub>GS</sub>	± 20	
– Non-repetitive (t <sub>p</sub> ≤ 10 ms)			
Drain Current	I <sub>D</sub>	20	Adc
– Continuous @ T <sub>A</sub> = 25°C	I <sub>D</sub>	10	
– Continuous @ T <sub>A</sub> = 100°C	I <sub>DM</sub>	60	Apk
– Single Pulse (t <sub>p</sub> ≤ 10 μs)			
Total Power Dissipation @ T <sub>A</sub> = 25°C	P <sub>D</sub>	60	W
Derate above 25°C		0.40	W/°C
Total Power Dissipation @ T <sub>A</sub> = 25°C (Note 1)		1.88	W
Total Power Dissipation @ T <sub>A</sub> = 25°C (Note 2)		1.36	W
Operating and Storage Temperature Range	T <sub>J</sub> , T <sub>stg</sub>	-55 to +175	°C
Single Pulse Drain-to-Source Avalanche Energy – Starting T <sub>J</sub> = 25°C (V <sub>DD</sub> = 25 Vdc, V <sub>GS</sub> = 5.0 Vdc, L = 1.0 mH, I <sub>L(pk)</sub> = 16 A, V <sub>DS</sub> = 60 Vdc)	E <sub>AS</sub>	128	mJ
Thermal Resistance	R <sub>θJC</sub>	2.5	°C/W
– Junction-to-Case	R <sub>θJA</sub>	80	
– Junction-to-Ambient (Note 1)	R <sub>θJA</sub>	110	
– Junction-to-Ambient (Note 2)			
Maximum Lead Temperature for Soldering Purposes, 1/8 in from case for 10 seconds	T <sub>L</sub>	260	°C

Maximum ratings are those values beyond which device damage can occur. Maximum ratings applied to the device are individual stress limit values (not normal operating conditions) and are not valid simultaneously. If these limits are exceeded, device functional operation is not implied, damage may occur and reliability may be affected.

1. When surface mounted to an FR4 board using 1 in pad size, (Cu Area 1.127 in<sup>2</sup>).
2. When surface mounted to an FR4 board using recommended pad size, (Cu Area 0.412 in<sup>2</sup>).



ON Semiconductor®

<http://onsemi.com>

V <sub>(BR)DSS</sub>	R <sub>DS(on)</sub> TYP	I <sub>D</sub> MAX
60 V	39 mΩ@5.0 V	20 A (Note 1)

#### N-Channel

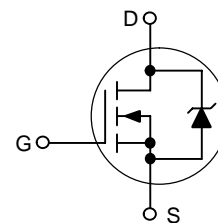

#### MARKING DIAGRAMS & PIN ASSIGNMENTS

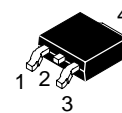

DPAK  
CASE 369C  
(Surface Mount)  
STYLE 2

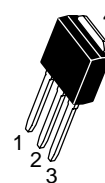
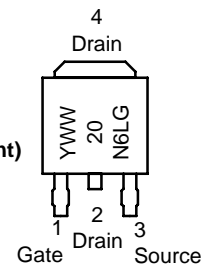

DPAK  
CASE 369D  
(Straight Lead)  
STYLE 2

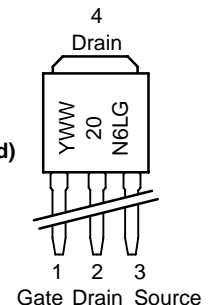

Y = Year  
WW = Work Week  
20N6L = Device Code  
G = Pb-Free Package

#### ORDERING INFORMATION

See detailed ordering and shipping information in the package dimensions section on page 2 of this data sheet.

# NTD20N06L

## ELECTRICAL CHARACTERISTICS (T<sub>J</sub> = 25°C unless otherwise noted)

Characteristic	Symbol	Min	Typ	Max	Unit
<b>OFF CHARACTERISTICS</b>					
Drain-to-Source Breakdown Voltage (Note 3) (V <sub>GS</sub> = 0 Vdc, I <sub>D</sub> = 250 μAdc) Temperature Coefficient (Positive)	V <sub>(BR)DSS</sub>	60 –	71.3 71.2	– –	Vdc mV/°C
Zero Gate Voltage Drain Current (V <sub>DS</sub> = 60 Vdc, V <sub>GS</sub> = 0 Vdc) (V <sub>DS</sub> = 60 Vdc, V <sub>GS</sub> = 0 Vdc, T <sub>J</sub> = 150°C)	I <sub>DSS</sub>	– –	– –	1.0 10	μAdc
Gate-Body Leakage Current (V <sub>GS</sub> = ±15 Vdc, V <sub>DS</sub> = 0 Vdc)	I <sub>GSS</sub>	–	–	±100	nAdc

## ON CHARACTERISTICS (Note 3)

Gate Threshold Voltage (Note 3) (V <sub>DS</sub> = V <sub>GS</sub> , I <sub>D</sub> = 250 μAdc) Threshold Temperature Coefficient (Negative)	V <sub>GS(th)</sub>	1.0 –	1.6 4.6	2.0 –	Vdc mV/°C
Static Drain-to-Source On-Resistance (Note 3) (V <sub>GS</sub> = 5.0 Vdc, I <sub>D</sub> = 10 Adc)	R <sub>DS(on)</sub>	–	39	48	mΩ
Static Drain-to-Source On-Resistance (Note 3) (V <sub>GS</sub> = 5.0 Vdc, I <sub>D</sub> = 20 Adc) (V <sub>GS</sub> = 5.0 Vdc, I <sub>D</sub> = 10 Adc, T <sub>J</sub> = 150°C)	V <sub>DS(on)</sub>	– –	0.81 0.72	1.66 –	Vdc
Forward Transconductance (Note 3) (V <sub>DS</sub> = 4.0 Vdc, I <sub>D</sub> = 10 Adc)	g <sub>FS</sub>	–	17.5	–	mhos

## DYNAMIC CHARACTERISTICS

Input Capacitance	(V <sub>DS</sub> = 25 Vdc, V <sub>GS</sub> = 0 Vdc, f = 1.0 MHz)	C <sub>iss</sub>	–	707	990	pF
Output Capacitance		C <sub>oss</sub>	–	224	320	
Transfer Capacitance		C <sub>rss</sub>	–	72	105	

## SWITCHING CHARACTERISTICS (Note 4)

Turn-On Delay Time	(V <sub>DD</sub> = 30 Vdc, I <sub>D</sub> = 20 Adc, V <sub>GS</sub> = 5.0 Vdc, R <sub>G</sub> = 9.1 Ω) (Note 3)	t <sub>d(on)</sub>	–	9.6	20	ns
Rise Time		t <sub>r</sub>	–	98	200	
Turn-Off Delay Time		t <sub>d(off)</sub>	–	25	50	
Fall Time		t <sub>f</sub>	–	62	120	
Gate Charge	(V <sub>DS</sub> = 48 Vdc, I <sub>D</sub> = 20 Adc, V <sub>GS</sub> = 5.0 Vdc) (Note 3)	Q <sub>T</sub>	–	16.6	32	nC
		Q <sub>1</sub>	–	5.5	–	
		Q <sub>2</sub>	–	8.5	–	

## SOURCE-DRAIN DIODE CHARACTERISTICS

Forward On-Voltage	(I <sub>S</sub> = 20 Adc, V <sub>GS</sub> = 0 Vdc) (Note 3) (I <sub>S</sub> = 20 Adc, V <sub>GS</sub> = 0 Vdc, T <sub>J</sub> = 150°C)	V <sub>SD</sub>	– –	0.97 0.85	1.2 –	Vdc
Reverse Recovery Time	(I <sub>S</sub> = 20 Adc, V <sub>GS</sub> = 0 Vdc, di <sub>S</sub> /dt = 100 A/μs) (Note 3)	t <sub>rr</sub>	–	42	–	ns
		t <sub>a</sub>	–	30	–	
		t <sub>b</sub>	–	12	–	
Reverse Recovery Stored Charge		Q <sub>RR</sub>	–	0.066	–	μC

3. Pulse Test: Pulse Width ≤ 300 μs, Duty Cycle ≤ 2%.  
4. Switching characteristics are independent of operating junction temperatures.

## ORDERING INFORMATION

Device	Package	Shipping†
NTD20N06L	DPAK	75 Units / Rail
NTD20N06LG	DPAK (Pb-Free)	75 Units / Rail
NTD20N06L-1	DPAK (Straight Lead)	75 Units / Rail
NTD20N06L-1G	DPAK (Straight Lead) (Pb-Free)	75 Units / Rail
NTD20N06LT4	DPAK	2500 Units / Tape & Reel
NTD20N06LT4G	DPAK (Pb-Free)	2500 Units / Tape & Reel

†For information on tape and reel specifications, including part orientation and tape sizes, please refer to our Tape and Reel Packaging Specifications Brochure, BRD8011/D.

# NTD20N06L

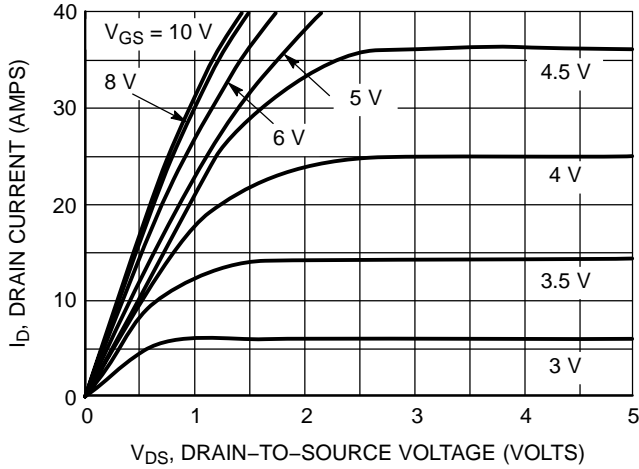

**Figure 1. On-Region Characteristics**

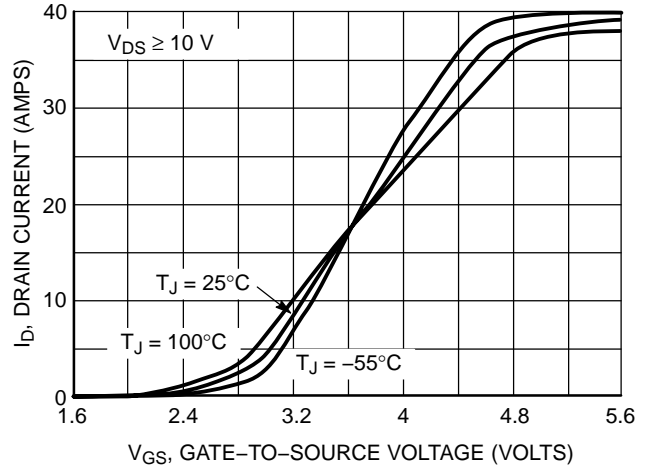

**Figure 2. Transfer Characteristics**

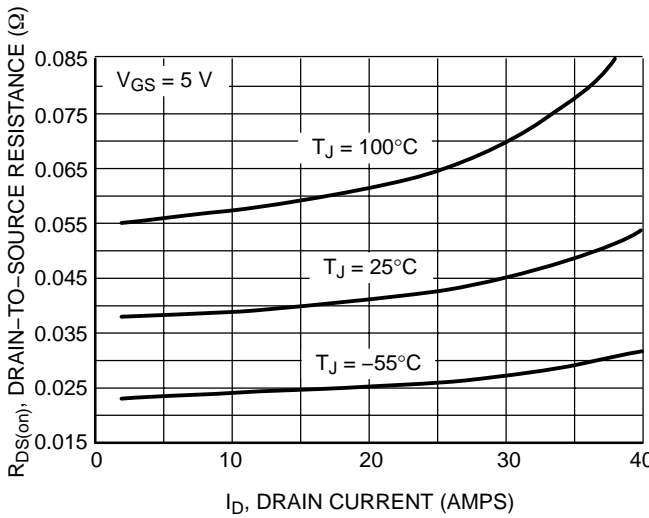

**Figure 3. On-Resistance versus Gate-to-Source Voltage**

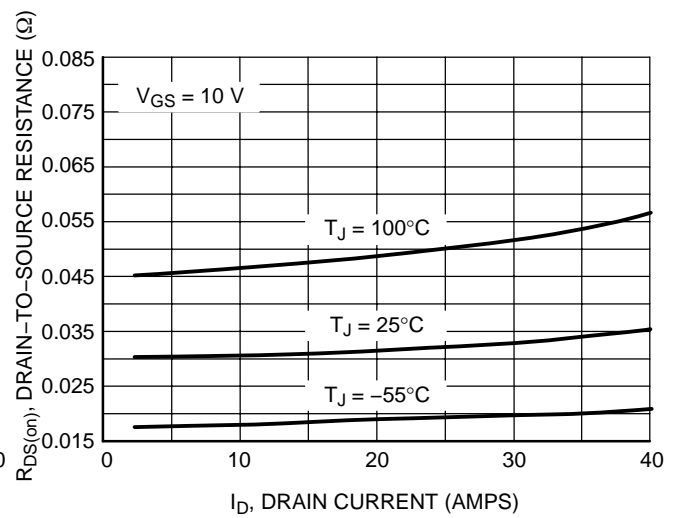

**Figure 4. On-Resistance versus Drain Current and Gate Voltage**

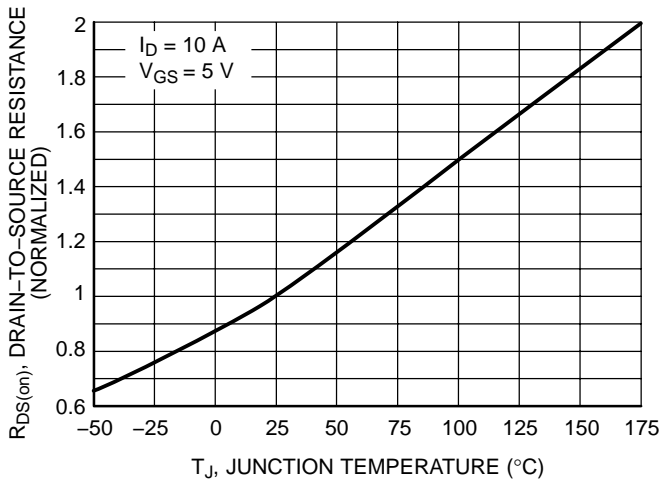

**Figure 5. On-Resistance Variation with Temperature**

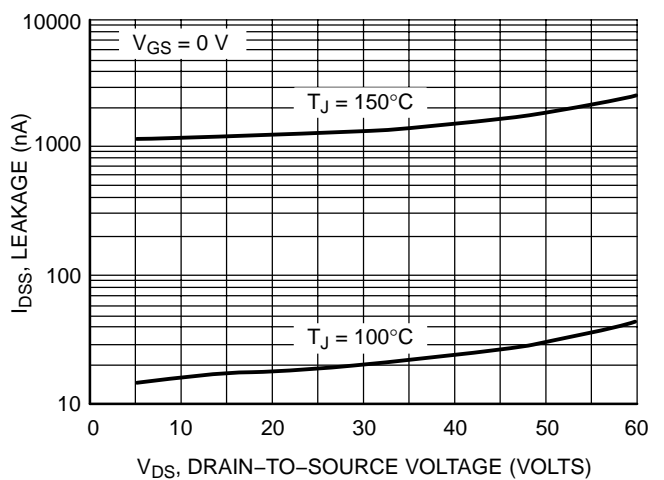

**Figure 6. Drain-to-Source Leakage Current versus Voltage**

POWER MOSFET SWITCHING

Switching behavior is most easily modeled and predicted by recognizing that the power MOSFET is charge controlled. The lengths of various switching intervals ( $\Delta t$ ) are determined by how fast the FET input capacitance can be charged by current from the generator.

The published capacitance data is difficult to use for calculating rise and fall because drain-gate capacitance varies greatly with applied voltage. Accordingly, gate charge data is used. In most cases, a satisfactory estimate of average input current ( $I_{G(AV)}$ ) can be made from a rudimentary analysis of the drive circuit so that

$$t = Q/I_{G(AV)}$$

During the rise and fall time interval when switching a resistive load,  $V_{GS}$  remains virtually constant at a level known as the plateau voltage,  $V_{SGP}$ . Therefore, rise and fall times may be approximated by the following:

$$t_r = Q_2 \times R_G / (V_{GG} - V_{SGP})$$

$$t_f = Q_2 \times R_G / V_{SGP}$$

where

$V_{GG}$  = the gate drive voltage, which varies from zero to  $V_{GG}$

$R_G$  = the gate drive resistance

and  $Q_2$  and  $V_{SGP}$  are read from the gate charge curve.

During the turn-on and turn-off delay times, gate current is not constant. The simplest calculation uses appropriate values from the capacitance curves in a standard equation for voltage change in an RC network. The equations are:

$$t_{d(on)} = R_G C_{iss} \ln [V_{GG}/(V_{GG} - V_{SGP})]$$

$$t_{d(off)} = R_G C_{iss} \ln (V_{GG}/V_{SGP})$$

The capacitance ( $C_{iss}$ ) is read from the capacitance curve at a voltage corresponding to the off-state condition when calculating  $t_{d(on)}$  and is read at a voltage corresponding to the on-state when calculating  $t_{d(off)}$ .

At high switching speeds, parasitic circuit elements complicate the analysis. The inductance of the MOSFET source lead, inside the package and in the circuit wiring which is common to both the drain and gate current paths, produces a voltage at the source which reduces the gate drive current. The voltage is determined by  $L di/dt$ , but since  $di/dt$  is a function of drain current, the mathematical solution is complex. The MOSFET output capacitance also complicates the mathematics. And finally, MOSFETs have finite internal gate resistance which effectively adds to the resistance of the driving source, but the internal resistance is difficult to measure and, consequently, is not specified.

The resistive switching time variation versus gate resistance (Figure 9) shows how typical switching performance is affected by the parasitic circuit elements. If the parasitics were not present, the slope of the curves would maintain a value of unity regardless of the switching speed. The circuit used to obtain the data is constructed to minimize common inductance in the drain and gate circuit loops and is believed readily achievable with board mounted components. Most power electronic loads are inductive; the data in the figure is taken with a resistive load, which approximates an optimally snubbed inductive load. Power MOSFETs may be safely operated into an inductive load; however, snubbing reduces switching losses.

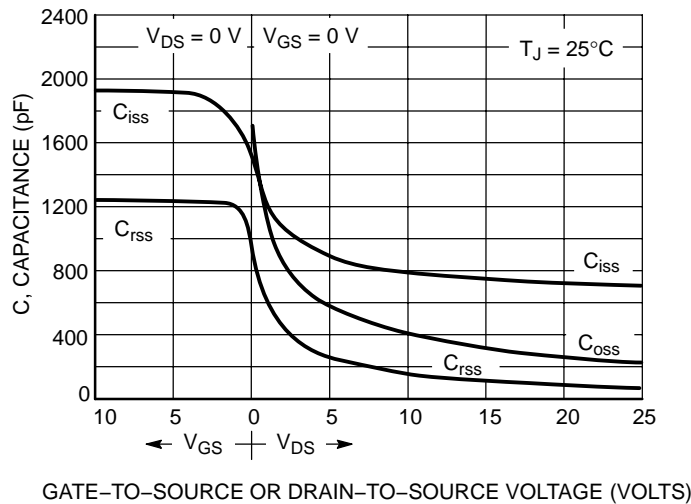
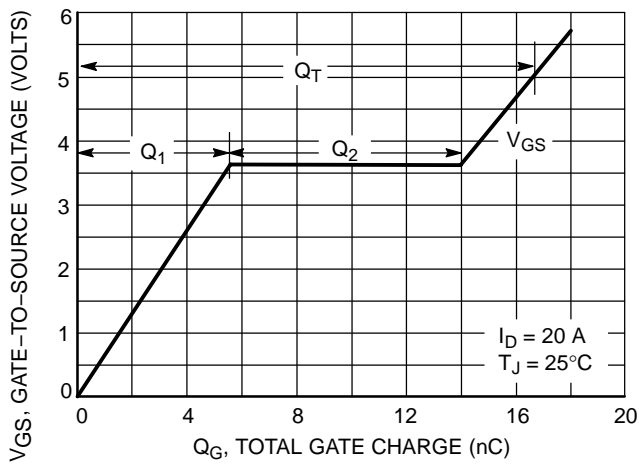
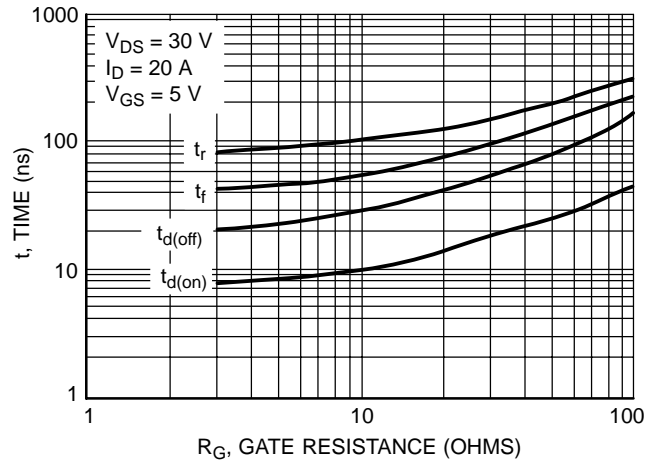

Figure 7. Capacitance Variation

## NTD20N06L

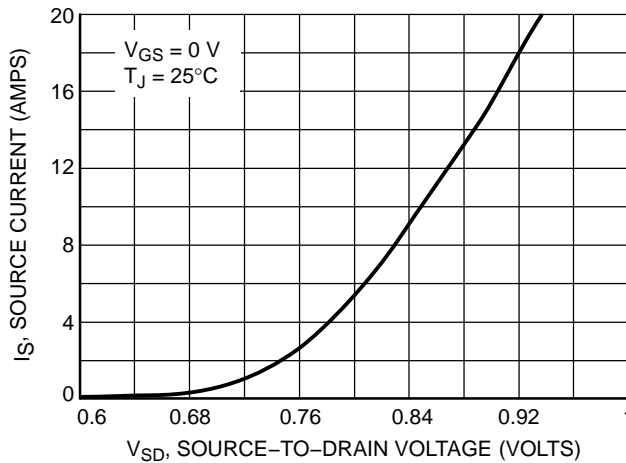

**Figure 8. Gate-to-Source and Drain-to-Source Voltage versus Total Charge**



**Figure 9. Resistive Switching Time Variation versus Gate Resistance**

### DRAIN-TO-SOURCE DIODE CHARACTERISTICS



**Figure 10. Diode Forward Voltage versus Current**

### SAFE OPERATING AREA

The Forward Biased Safe Operating Area curves define the maximum simultaneous drain-to-source voltage and drain current that a transistor can handle safely when it is forward biased. Curves are based upon maximum peak junction temperature and a case temperature ( $T_C$ ) of 25°C. Peak repetitive pulsed power limits are determined by using the thermal response data in conjunction with the procedures discussed in AN569, “Transient Thermal Resistance – General Data and Its Use.”

Switching between the off-state and the on-state may traverse any load line provided neither rated peak current ( $I_{DM}$ ) nor rated voltage ( $V_{DSS}$ ) is exceeded and the transition time ( $t_r, t_f$ ) do not exceed 10  $\mu s$ . In addition the total power averaged over a complete switching cycle must not exceed  $(T_{J(MAX)} - T_C)/(R_{\theta JC})$ .

A Power MOSFET designated E-FET can be safely used in switching circuits with unclamped inductive loads. For

reliable operation, the stored energy from circuit inductance dissipated in the transistor while in avalanche must be less than the rated limit and adjusted for operating conditions differing from those specified. Although industry practice is to rate in terms of energy, avalanche energy capability is not a constant. The energy rating decreases non-linearly with an increase of peak current in avalanche and peak junction temperature.

Although many E-FETs can withstand the stress of drain-to-source avalanche at currents up to rated pulsed current ( $I_{DM}$ ), the energy rating is specified at rated continuous current ( $I_D$ ), in accordance with industry custom. The energy rating must be derated for temperature as shown in the accompanying graph (Figure 12). Maximum energy at currents below rated continuous  $I_D$  can safely be assumed to equal the values indicated.

# NTD20N06L

## SAFE OPERATING AREA

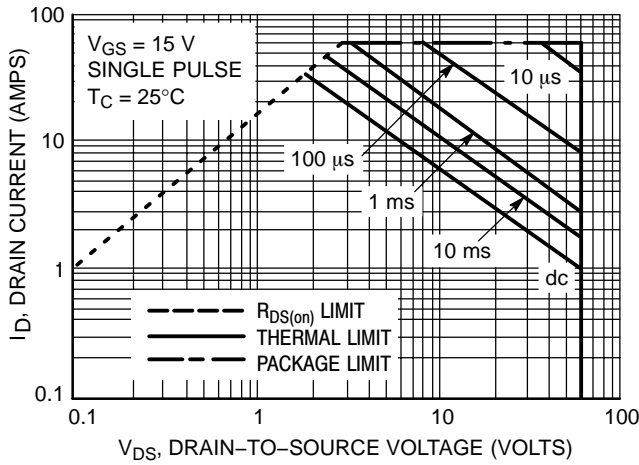

Figure 11. Maximum Rated Forward Biased Safe Operating Area

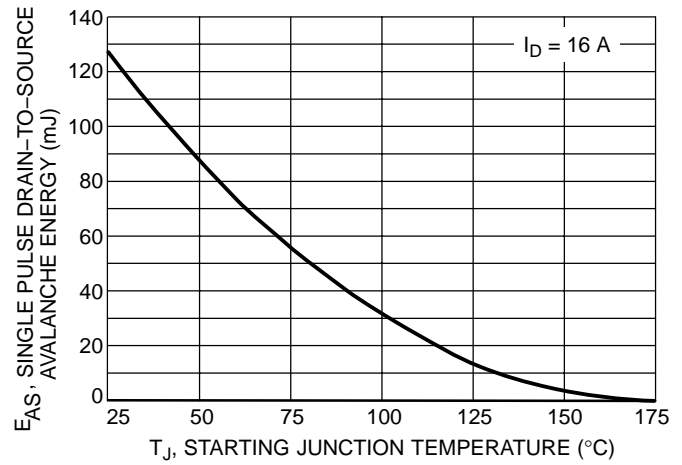

Figure 12. Maximum Avalanche Energy versus Starting Junction Temperature

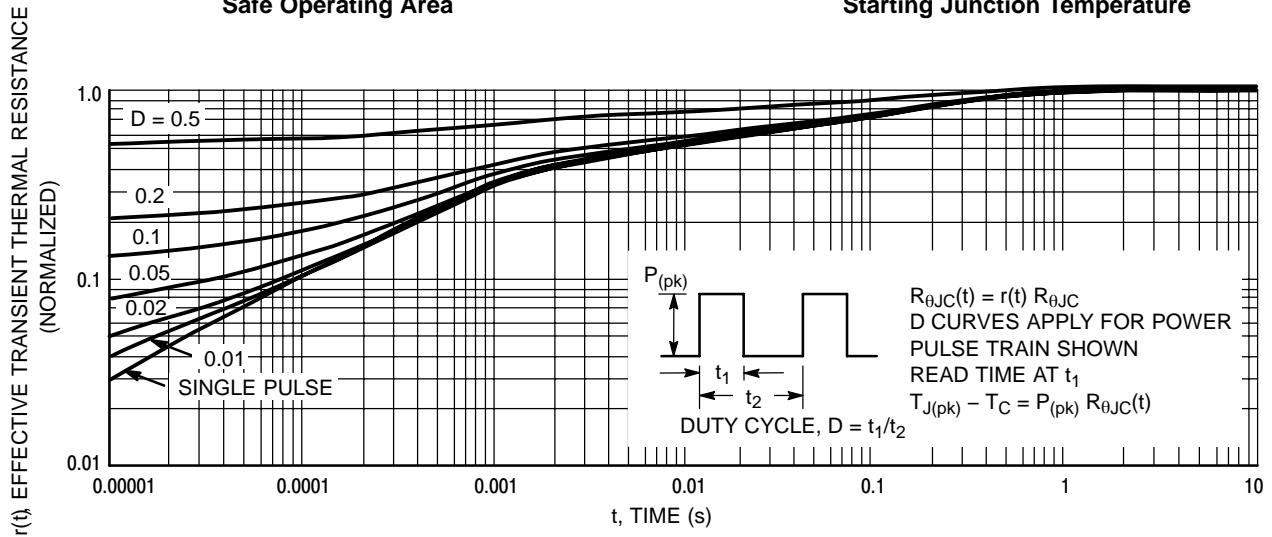

Figure 13. Thermal Response

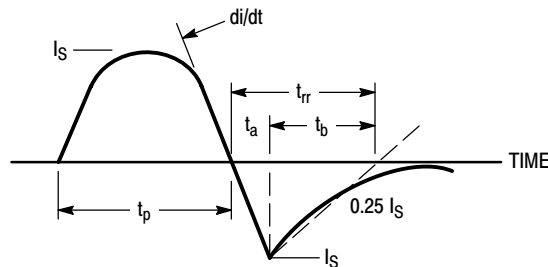
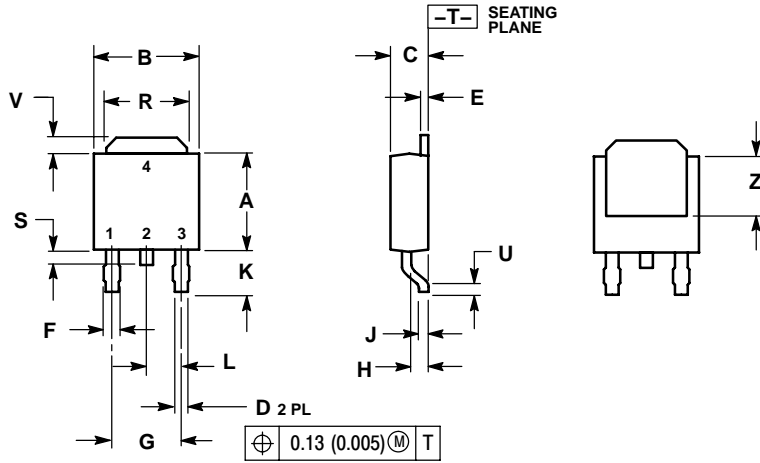

Figure 14. Diode Reverse Recovery Waveform

# NTD20N06L

## PACKAGE DIMENSIONS

DPAK  
CASE 369C-01  
ISSUE O



- NOTES:  
1. DIMENSIONING AND TOLERANCING PER ANSI Y14.5M, 1982.  
2. CONTROLLING DIMENSION: INCH.

DIM	INCHES		MILLIMETERS	
	MIN	MAX	MIN	MAX
A	0.235	0.245	5.97	6.22
B	0.250	0.265	6.35	6.73
C	0.086	0.094	2.19	2.38
D	0.027	0.035	0.69	0.88
E	0.018	0.023	0.46	0.58
F	0.037	0.045	0.94	1.14
G	0.180 BSC		4.58 BSC	
H	0.034	0.040	0.87	1.01
J	0.018	0.023	0.46	0.58
K	0.102	0.114	2.60	2.89
L	0.090 BSC		2.29 BSC	
R	0.180	0.215	4.57	5.45
S	0.025	0.040	0.63	1.01
U	0.020	---	0.51	---
V	0.035	0.050	0.89	1.27
Z	0.155	---	3.93	---

- STYLE 2:  
PIN 1. GATE  
2. DRAIN  
3. SOURCE  
4. DRAIN

### SOLDERING FOOTPRINT\*

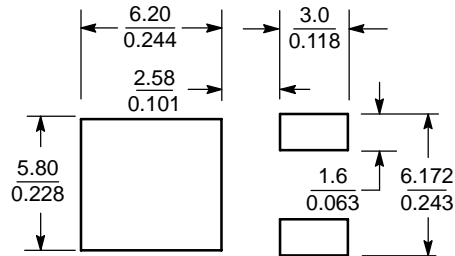

SCALE 3:1  $\left(\frac{\text{mm}}{\text{inches}}\right)$

\*For additional information on our Pb-Free strategy and soldering details, please download the ON Semiconductor Soldering and Mounting Techniques Reference Manual, SOLDERRM/D.

# NTD20N06L

## PACKAGE DIMENSIONS

DPAK  
CASE 369D-01  
ISSUE B

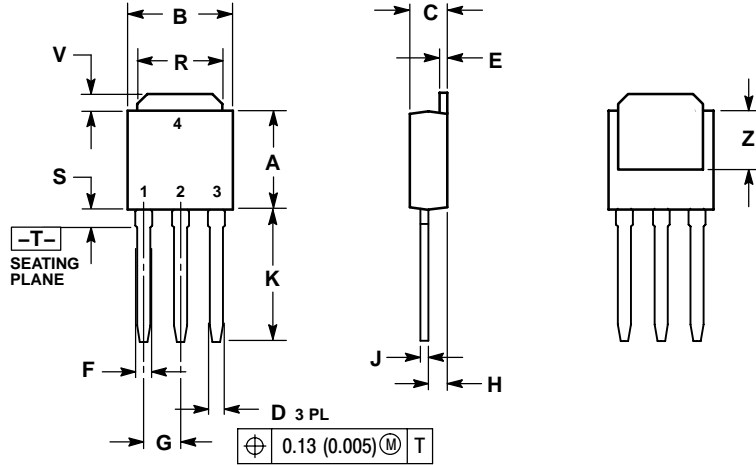

NOTES:

1. DIMENSIONING AND TOLERANCING PER ANSI Y14.5M, 1982.
2. CONTROLLING DIMENSION: INCH.

DIM	INCHES		MILLIMETERS	
	MIN	MAX	MIN	MAX
A	0.235	0.245	5.97	6.35
B	0.250	0.265	6.35	6.73
C	0.086	0.094	2.19	2.38
D	0.027	0.035	0.69	0.88
E	0.018	0.023	0.46	0.58
F	0.037	0.045	0.94	1.14
G	0.090 BSC		2.29 BSC	
H	0.034	0.040	0.87	1.01
J	0.018	0.023	0.46	0.58
K	0.350	0.380	8.89	9.65
R	0.180	0.215	4.45	5.45
S	0.025	0.040	0.63	1.01
V	0.035	0.050	0.89	1.27
Z	0.155	---	3.93	---

STYLE 2:

- PIN 1. GATE  
2. DRAIN  
3. SOURCE  
4. DRAIN

ON Semiconductor and are registered trademarks of Semiconductor Components Industries, LLC (SCILLC). SCILLC reserves the right to make changes without further notice to any products herein. SCILLC makes no warranty, representation or guarantee regarding the suitability of its products for any particular purpose, nor does SCILLC assume any liability arising out of the application or use of any product or circuit, and specifically disclaims any and all liability, including without limitation special, consequential or incidental damages. "Typical" parameters which may be provided in SCILLC data sheets and/or specifications can and do vary in different applications and actual performance may vary over time. All operating parameters, including "Typicals" must be validated for each customer application by customer's technical experts. SCILLC does not convey any license under its patent rights nor the rights of others. SCILLC products are not designed, intended, or authorized for use as components in systems intended for surgical implant into the body, or other applications intended to support or sustain life, or for any other application in which the failure of the SCILLC product could create a situation where personal injury or death may occur. Should Buyer purchase or use SCILLC products for any such unintended or unauthorized application, Buyer shall indemnify and hold SCILLC and its officers, employees, subsidiaries, affiliates, and distributors harmless against all claims, costs, damages, and expenses, and reasonable attorney fees arising out of, directly or indirectly, any claim of personal injury or death associated with such unintended or unauthorized use, even if such claim alleges that SCILLC was negligent regarding the design or manufacture of the part. SCILLC is an Equal Opportunity/Affirmative Action Employer. This literature is subject to all applicable copyright laws and is not for resale in any manner.

### PUBLICATION ORDERING INFORMATION

**LITERATURE FULFILLMENT:**  
Literature Distribution Center for ON Semiconductor  
P.O. Box 61312, Phoenix, Arizona 85082-1312 USA  
**Phone:** 480-829-7710 or 800-344-3860 Toll Free USA/Canada  
**Fax:** 480-829-7709 or 800-344-3867 Toll Free USA/Canada  
**Email:** orderlit@onsemi.com

**N. American Technical Support:** 800-282-9855 Toll Free  
USA/Canada

**Japan:** ON Semiconductor, Japan Customer Focus Center  
2-9-1 Kamimeguro, Meguro-ku, Tokyo, Japan 153-0051  
**Phone:** 81-3-5773-3850

**ON Semiconductor Website:** <http://onsemi.com>

**Order Literature:** <http://www.onsemi.com/litorder>

For additional information, please contact your local Sales Representative.